



www.monoequip.com

Enter **Serial No.** here. _____

In the event of an enquiry please quote this serial number.



SET UP and OPERATION

AUTO JAMMER/INJECTOR



DECLARATION OF CONFORMITY

We hereby declare that this machine complies with the essential health and safety requirements of :-

- The Machinery Directive 2006 / 42 / EC
- The Low voltage Directive 2014 / 35/ EC
- The requirements of the Electromagnetic Compatibility Directive 2004 / 108EC, 91 / 263 / EEC, 92 / 31 / EEC
Incorporating standards
EN55014-1:2006+A1:2009+A2:2011
EN55014-2:1997+A1:2001+A2:2008
- The General Safety of Machinery and food processing Standards applicable
- Materials and Articles intended to come into contact with food
Regulation (EC) No. 1935 / 2004

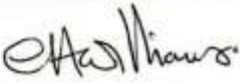
Signed	
G.A.Williams – Quality Manager	

Date	
-------------	--

Machine FG Code.		Machine Serial No.	
-----------------------------	--	-------------------------------	--

A technical construction file for this machine is retained at the following address:

MONO EQUIPMENT
Queensway,
Swansea West Industrial Park,
Swansea
SA5 4EB
UK

MONO EQUIPMENT is a business name of **AFF GROUP Ltd**
Registered in England No.3872673 VAT registration No.923428136

Registered office: Unit 9, Bryggen Road,
North Lynn Industrial Estate,
Kings Lynn,
Norfolk,
PE30 2HZ

SAFETY SYMBOLS

The following safety symbols are used throughout this product documentation and manual (available at www.monoequip.com).

Before using your new equipment, read the instruction manual carefully and pay special attention to information marked with the following symbols.



WARNING

Indicates a hazardous situation which, if not avoided, will result in death or serious injury.



WARNING

Indicates a hazardous situation which, if not avoided, will result in electric shock.



CAUTION

Indicates a hazardous situation which, if not avoided, will result in minor or moderate injury.

ELECTRICAL SAFETY AND ADVICE REGARDING SUPPLEMENTARY ELECTRICAL PROTECTION:

Commercial bakeries, kitchens and foodservice areas are environments where electrical appliances may be located close to liquids or operate in and around damp conditions or where restricted movement for installation and service is evident.

The installation and periodic inspection of the appliance should only be undertaken by a qualified, skilled and competent electrician, and connected to the correct supply suitable for the load as stipulated by the appliance data label.

The electrical installation and connections should meet the necessary requirements of the local electrical wiring regulations and any electrical safety guidelines.

We Recommend:

- Supplementary electrical protection with the use of a residual current device (RCD)
- Fixed wiring appliances incorporate a locally situated switch disconnecter to connect to, which is easily accessible for switching off and safe isolation purposes. The switch disconnecter must meet the specification requirements of IEC 60947.



The supply to this machine must be protected by a **30mA RCD**

Failure to adhere to the cleaning and maintenance instructions detailed in this booklet could affect the warranty of this machine

ONLY FOR USE WITH SEEDLESS FILLINGS



INDEX



- 1.0 INTRODUCTION**
- 2.0 DIMENSIONS**
- 3.0 SPECIFICATIONS**
- 4.0 SAFETY**
- 5.0 INSTALLATION**
- 6.0 ISOLATION**
- 7.0 CLEANING INSTRUCTIONS**
- 8.0 OPERATING CONDITIONS**
- 9.0 OPERATING INSTRUCTIONS**
 - Select operation mode**
 - Select program you want to create or modify**
 - Enter new or modify existing parameters**
 - Running a program**
 - Change a programs parameters on the fly**
- 10.0 MAINTENANCE**
- 11.0 PROBLEM SOLVING**
- 12.0 SPARES AND SERVICE**
- 13.0 ELECTRICAL INFORMATION**

1.0 INTRODUCTION

Mono's Auto Jammer/Injector can fill doughnuts and pastries two at a time without mess or waste. It can also be used to fill pastries on trays via a tube and gun. Fillings are precisely dispensed through nozzles or gun in variable, pre-set amounts. To change fillings halfway through a run – just lift the filler unit from the console and replace it with another unit containing the new filling. Mono's Auto Jammer/Injector is simple to operate and programme – and really easy to keep clean.

2.0 DIMENSIONS

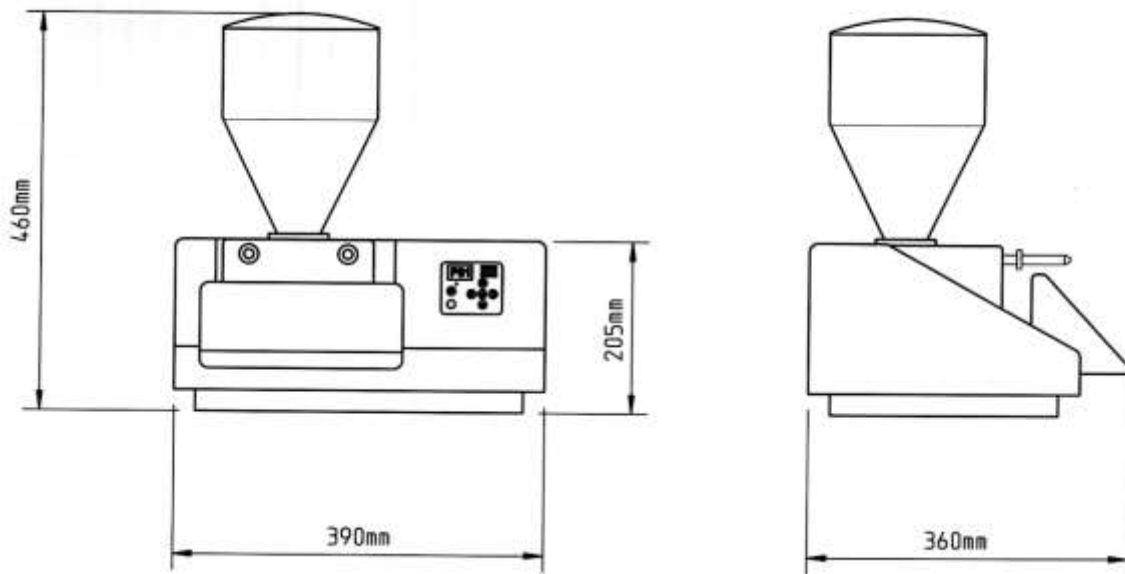

Height (<i>with hopper</i>)	460mm	(18")
Height (<i>without hopper</i>)	205mm	(8")
Depth (<i>including tray</i>)	360mm	(14")
Width	390mm	(15 ½")

3.0 SPECIFICATIONS

Weight (*without filling*) TBA

Hopper capacity 9.1kg (20lbs)

Single delivery capacity TBA

These figures can vary depending on the filling used.

WARNING.

Only to be used with seedless jams and fillings

ELECTRICAL REQUIREMENTS

See serial plate for machine version.

100-250volt 1 phase 50-60Hz

Total power 100Watts @ 24Vdc 6.26 amps



The supply to this machine must be protected by a **30mA RCD**

NOISE LEVEL

Less than 85dB

4.0 SAFETY



-
- 1.0 Always use the nearest available socket to the machine avoiding cables trailing across the floor.
 - 2.0 Plugs on flexible cables must be correctly connected and the cable secured by the cord grip.
 - 3.0 Flexible cables should be positioned and protected so that heavy equipment or materials cannot damage them.
 - 4.0 Cables should be checked regularly for damage (checks should be made with the cable disconnected from the mains).
 - 5.0 Damaged cables should be taken out of service straight away.
 - 6.0 Do not carry out makeshift repairs to cables
 - 7.0 Loose or damaged plugs must be replaced immediately.



- 8.0 Never immerse the base console in water.
- 9.0 Always remove hopper before lifting or moving the base unit.
- 10.0 All repairs and maintenance should only be carried out by authorised electricians.
- 11.0 Only trained and authorised personnel may operate or clean this machine.
- 12.0 Never leave machine unattended without switching off.
- 13.0 There are no user serviceable parts inside the machine. If a fault occurs please contact Mono service department.



- 14.0 When in use and when cleaning be aware that the injection nozzles could be sharp.

5.0 INSTALLATION

- 1 The Mono electronic doughnut jammer should be plugged into a 13 amp socket.



The supply to this machine must be protected by a **30mA RCD**

- 2 For best results the electronic jammer should be placed in a clean work area and on a level surface at a normal work top height.
- 3 Before first use, wash out the hopper parts with a suitably approved cleaner and water. Allow to air dry.

6.0 ISOLATION



**TO STOP THE ELECTRONIC JAMMER / INJECTOR
IN AN EMERGENCY, SWITCH OFF AT THE WALL
SOCKET.**

7.0 CLEANING INSTRUCTIONS



ISOLATE FROM MAINS SUPPLY BEFORE CLEANING

NEVER IMMERSE THE BASE UNIT IN WATER.

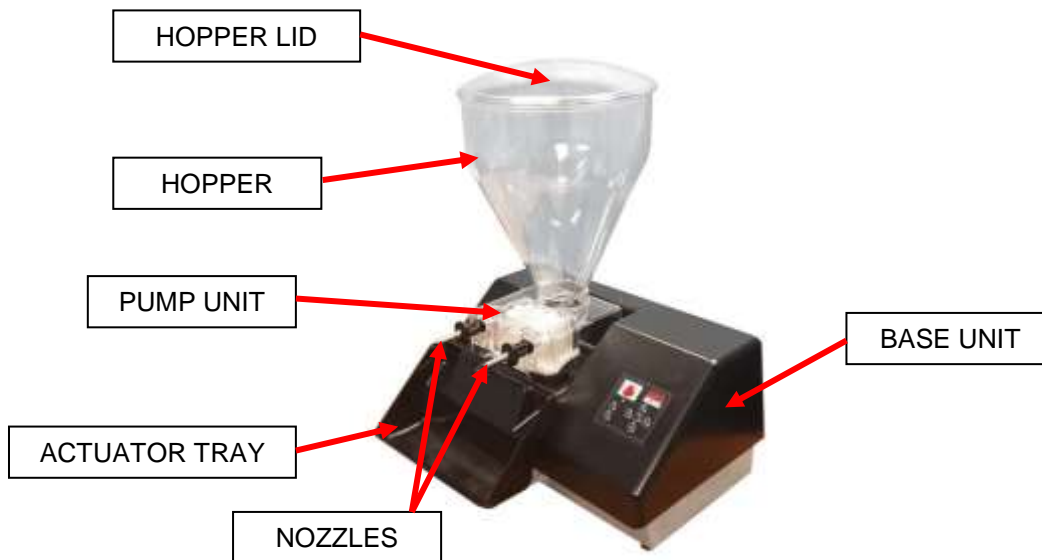

The machine should be cleaned and all components allowed to air dry after every period of use.

- 1.0 Remove the nozzles by twisting each one until the flat of the plastic ring lines up with the flat on the pump unit. Pull completely out and wash with an approved mild detergent/sanitizer and hot water. Allow to air dry.



Take care when removing nozzles as they may be sharp.

- 2.0 Empty the hopper into a container and cover over for future use.
DO NOT TOP UP A HALF FULL CONTAINER.
- 3.0 Dismantle the pump chamber components as shown below (6.0) and wash thoroughly with an approved cleaner and water.
- 4.0 Wash the hopper unit and the entire lid with an approved mild detergent/sanitizer and hot water. Allow to air dry.
- 5.0 Air dry all the pump components and reassemble the impellers (3) on the correct spindles with the recessed side facing down.
DO NOT USE FORCE

- 6.0** Replace the impellor unit in the pump chamber ensuring the seal (4) is in place and fasten with the thumb screws (1)
These screws should only be finger tight as the use of tools to over tighten could lead to the chamber cover fracturing.

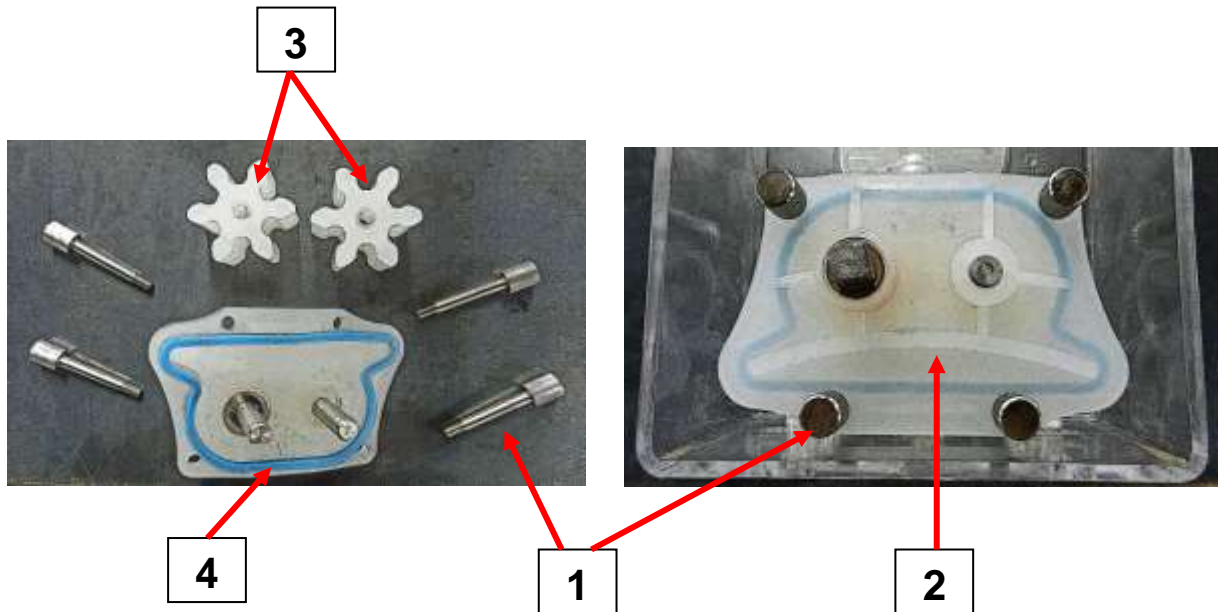

- 7.0** Unclip the actuator tray and wash thoroughly using an approved cleaner and water. Allow to air dry.
- 8.0** **Wipe over** all external surfaces with an approved mild detergent/sanitiser and hot water. Allow to air dry.
- 9.0** Insert each nozzle into the pump unit with the flat of the plastic ring facing down. When the nozzle has been inserted as far as the ring, twist it through 90 degrees. See below
-  Take care when inserting nozzles as they may be sharp.

FITTING NOZZLES

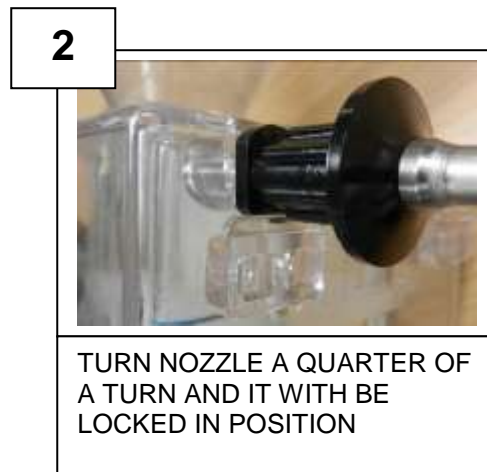

8.0 OPERATING CONDITIONS ---

- 1.0 For best results the electronic jammer should be placed on a level surface at a normal work top height.
- 2.0 All cleaning and operation instructions should be followed meticulously.

NEVER DO THE FOLLOWING:



1. NEVER power on the unit if huge liquid leakage has gone inside the plastic case. Ask for service.
2. NEVER replace the rear 6.3A 5x20 Ceramic Slow-Blow fuse of the rear panel with a different type. And if the fuse gets blown, ask for service.
3. If for some reason the motor does not start, switch off and ask for service.
4. Never pour liquid over the unit
5. Never use a different power supply
6. Never use a knife or other sharp object to press the keyboard buttons

Do not press the display area: **it is not a touch screen** and the underneath OLED display can be damaged.



9.0 OPERATING INSTRUCTIONS



- 1.0 Plug the socket of the moulded cable assembly into the rear of the base console.
- 2.0 Insert the plug of the cable into a 13amp wall socket.

The Jammer is delivered with a (limited) standard set of programs but can be easily reprogrammed. This section will show how to program the Jammer.

SELECT THE OPERATION MODE



After power ON, the Jammer starts in the so called “Home” status, showing the icon **P01** on the display.

Using the “Operation Mode / Program”  key, you can now choose the “Operation Mode”, selecting either the “Numeric Mode” or the “Icon Mode” or the “Manual mode” or the “Continuous Mode”. Just press the  key to roll the mode on the display. In sequence, you will see the display will show:

- **P01** for the “Numeric Mode”
-  for the “Icon Mode”
-  for the “Manual mode”
-  for the “Continuous Mode”

Once you have chosen the operation mode, it's immediately active. No need to confirm.

SELECT THE “PROGRAM” YOU WANT TO CREATE OR MODIFY

Once you have chosen the “**Operation Mode**”, you can move from icon to icon using the  or the  keys to select the desired Program inside the list.



When you buy the unit you will find a number of pre-set programs. With the procedure(s) described below you will be able to create new programs or to modify existing programs, but only for Numeric or Icon Operation mode.

The Manual Operation Mode has – instead – a unique choice.

The Continuous Mode will also be different.

➤ Moving through the Numerical Operation Mode.

- If you have previously selected the “**Numerical Mode**”, you will see progressive numbers of the icon, like **P01, P02, P03**, and so on.



You can move forward with the  key or move back with the  key until you have selected the Program inside the list, which you want to create or modify.

- Once the screen shows the program you want, it is active. No need to confirm.

➤ Moving through the Icon Operation Mode

- If you have selected the “**Icon Operation Mode**”, you will see icons, like



You can move forward with the  key or move back with the  key until you have selected the Program which you want to create or modify.

- Once you have selected the Program, that program is already active. No need to confirm.

➤ If the Icon is the **Manual Operation Mode**

- If you have previously selected the “**Manual Operation Mode**”, then you will see only

one icon



➤ If the Icon is the **Continuous Operation Mode**

- If you have selected the “**Continuous Operation Mode**” then you will see only one

icon, which is:



ENTER NEW OR MODIFY EXISTING PARAMETERS

The actions described below are valid for all the four Operation Modes: Numerical, Icon, Manual or Continuous.

Press the key  for at least 5 seconds to enter the Programming sequence.



SETTING THE INJECTION DURATION TIME

NOTICE: This step will not appear (i.e.: will be automatically by-passed) for the Continuous Operation Mode.

Unless previously set, the display will show the **Time** icon with an initial time value of

0.6 seconds: 

At this point, using the **Up**  and **Down**  keys, you can modify the value until you get the

desired value, for example:  , then confirm your choice by pressing:  .

NOTICE: the possible values range from 0.6s to 99s; you have intervals of 1/10th of seconds from 0.6s to 9.9s, then from 10s to 99s the interval is 1s.



After you confirm, the display will change to next step, showing the **Speed** icon.

SETTING THE SPEED OF THE INJECTION

NOTICE: This step is valid for all 4 operation modes.

Unless previously set, the display will show the **Speed** icon with an initial speed value

in rpm : 

At this point, using the **Up**  and **Down**  keys, you will modify the value of the speed until you get the desired value, then confirm your choice by pressing  .

After you confirm, the display will change to next step, showing the **Suck-Back** icon.

SETTING THE SUCK-BACK DURATION TIME

NOTICE: This step is valid for all 4 operation modes.

Unless previously set, the display will show the **Suck-Back** icon with an the initial time value

in seconds :  0.6

At this point, using the **Up**  and **Down**  keys, you can modify the value of the speed

Then confirm your choice by pressing .

NOTICE: the possible values range from 0.6s to 99s; you have intervals of 1/10th of seconds from 0.6s to 9.9s, then from 10s to 99s the interval is 1s.

NOTICE: if you have selected the **MANUAL** or the **CONTINUOUS** Operation Mode, the

procedure ends here and the Jammer will show the icon:  This means the input values are only temporary saved and will be lost at next power off/on of the Jammer.

If your previous choice was either the **Numerical Operation** or the **Icon** mode, the display will move on to next step, showing the **Order-in-Menu** icon.

SETTING THE PROGRAM ORDER

NOTICE: This step **will not appear** for the **Manual Operation Mode** or for the **Continuous Operation Mode**.



The display will show the “**PROGRAM ORDER**” icon with the actual Program’s value, e.g.:

 13

We have assumed, just for example, that at the beginning you have selected the Program #13 or the Icon in the 13th place of the Icons’ list. (This is **not** valid for the **Manual Operation Mode**).

To understand this feature, let’s say that the Program which you have just created, as new or modified (either **Numerical** or **Icon** mode) can be stored in a position in the list,

For example, if you have worked on a program which was originally **P13**, and you think it will be the most used, rename it as **P01**, so that it’s your first choice when you power up the Jammer.

To do this, use the **Up**  and **Down**  keys to modify the value of the position until you get the desired position.

When you have selected the position, just press  to confirm.

The Jammer will show the icon:  to confirm that everything has been stored correctly.

NOTICE: the new/modified parameters will be stored only for the **Numerical** or the **Icon Operation Mode**.

They will not be stored for the **Manual** or for the **Continuous Operation Mode**.

If you change the position of a program (icon) in the list, the other programs will move down one position.

Examples:

- **P01, P02, P03,**

If you modify P03 and then rename it P01.
then the new list will be:

P01 (formerly P03), **P02** (formerly P01), **P03** (formerly P02)

-  **GUEST**

If you are working on the Raspberry Icon and you would like it to become the first one.
After you save your work, you will have this new list:



IF YOU MAKE A PROGRAMMING ERROR

In case you realize you have entered a wrong value during the programming section, you have to re-enter the programming mode from the beginning.

Select the program (be careful if you have changed the position in the list!), and enter the new values.

RUNNING A PROGRAM



Below you will see how to choose your Operation Mode and how to choose the Program to be run.



CHOOSING THE OPERATION MODE

After power ON, the Jammer starts in the “Home” mode, displaying the icon **P01**.

Using the “Operation Mode / Program”  key, choose the mode required.



Press the  key to change the mode on the display.
In sequence, you will see the display will show:

- **P01** for the “**Numeric Mode**”
-  for the “**Icon Mode**” (NOTE: here we show the raspberry, but the Icon can be any other which was previously loaded to position #1)
-  for the “**Manual mode**”
-  for the “**Continuous Mode**”

Once you have chosen the mode, you can scroll through the icons using the  or the  keys to select the desired Program. This is only for Numerical or Icon Operation mode.

The Manual or the Continuous Operation Mode have choices as below:



Select the Program inside the **Numerical Operation Mode**

- If you have previously selected the “**Numerical Mode**”, you will see progressive numbers of the icon, like **P01**, **P02**, **P03** You can move forward with the  key or move back with the  key until you have selected the Program you wish to create or modify.
- **NOW YOU ARE READY TO RUN THE SELECTED PROGRAM**
The program will start as soon as you push either the Tray or the foot pedal (if fitted)

Select the Program inside the **Icon Operation Mode**

- If you have previously selected the “**Icon Operation Mode**”, you will see progressive

icons, like     **GUEST** and so on.

You can move forward with the  key or move back with the  key until you have selected the Program you wish to create or modify.

- **NOW YOU ARE READY TO RUN THE SELECTED PROGRAM**

The program will start as soon as you push either the Tray or the foot pedal (if fitted)

GUEST PROGRAM INSIDE THE ICON OPERATION MODE

If you have selected the **GUEST** icon, it means that you are running a “Test Program” for a new kind of Jam or Cream which is not in the icon list.

Factory settings for the Guest program can be modified (and saved)

The scope of the **GUEST** program is to give the opportunity to experiment with new settings, without “damaging” the settings of the other programs associated to the other icons.

GUEST is a program which can be used for ‘promotional’ flavours that the store may be running from time to time. It means that the flavour can be used for a while and then changed when the next promotion is run.

Therefore, the icon can be used for a variety of fillings that are to be on promotion for a limited period of time.

Select the **Manual Operation Mode**

- If you have selected the “**Manual Operation Mode**”, then you will see only one icon,

which is:  .

- **NOW YOU ARE READY TO RUN THE MANUAL PROGRAM**

The program will start as soon as you push either the Tray or the foot pedal (if fitted)

IMPORTANT NOTICE FOR RUNNING MANUAL PROGRAM

Notice that if you have selected the **Manual Operation Mode** then no parameter change has been saved.

The **Manual Operation Mode** runs with the last entered parameters after the Jammer has been powered on

If you do not change anything, you will run the **Manual Operation Mode** with the factory settings which are:

- **Ejection Time** = **05 seconds**
- **Motor Speed** = **99 rpm**
- **Suck-Back Time** = **03 seconds**

You can modify these settings and work with new parameters as long as the Jammer is kept powered on.

Select the **Continuous Operation Mode**

- If you have selected the “**Continuous Operation Mode**”, then you will see only one icon, which is:  .

- **NOW YOU ARE READY TO RUN THE CONTINUOUS PROGRAM**

The program will start as soon as you push the foot pedal (or also the front tray button). This will start the flow of the jam from the gun. The trigger must be open. You do not have to keep the foot pedal pressed all the time.

The flow will stop (with the pre-set suck-back time) when you press the foot pedal again.

So, the sequence for the Continuous Mode is:

- Press the foot pedal.....starts the flow
- Release the foot pedal.....flow continues
- Press the foot pedal.....flow stops (with preset suck-back).

IMPORTANT NOTICE FOR RUNNING CONTINUOUS PROGRAM

Notice that if you have selected the **CONTINUOUS Operation Mode** then no parameter change has been saved.

The **Manual Operation Mode** runs with the last entered parameters after the Jammer has been powered on.

If you do not change anything, you will run the **CONTINUOUS Operation Mode** with the factory settings which are:

- Motor Speed = **99** rpm
- Suck-Back Time = **03** seconds

CHANGE A PROGRAM'S PARAMETERS ON THE FLY

Sometimes you have chosen and run a program but you need to experiment with the settings. Maybe you have a larger pastry and want to change the program's injection time parameter, to allow more jam flow into the pastry.

To do this, follow the procedure described below:

- **YOU ARE IN THE "RUN PROGRAM" STATUS**

I.e.: you are ready to press either the tray Pushbutton or the foot pedal.

- At any time, press the  key, then follow the procedure below which is quite similar to the Programming sequence.

NOTICE:



- for Ejection & Suck-Back timings, the possible values range from 0.6s to 99s; you have intervals of 1/10th of seconds from 0.6s to 9.9s, then from 10s to 99s the interval is 1s.
- for Speed, values range from 01 to 99 rpm.

CHANGE THE INJECTION DURATION TIME

NOTICE: This step will not appear (i.e.: will be automatically by-passed) for the Continuous Operation Mode.

The display will show the **Time** icon with the actual preset value (e.g.: 12 seconds): .

At this point, using the **Up**  and **Down**  keys, you can modify the value until you get the

desired value, for example: . Then confirm your choice by pressing: .



The display will change to the next step, showing the **Speed** icon.

CHANGE THE SPEED OF THE INJECTION

NOTICE: This step is valid for all 4 operation modes.

The display will show the **Speed** icon with the actual speed value in rpm : .

At this point, using the **Up**  and **Down**  keys, you can modify the value of the speed

until you get the desired value, for example . Then confirm your choice by pressing .

The display will change to the next step, showing the **Suck-Back** icon.

CHANGE THE **SUCK-BACK** DURATION TIME

NOTICE: This step is valid for all 4 operation modes.

The display will show the **Suck-Back** icon with the actual time value in seconds, e.g.:

01

At this point, using the **Up**  and **Down**  keys, you can modify the value of the speed until you get the desired value, for example 03 (longer suck back time). Then confirm your choice by pressing .

NOTICE: the “change on the fly” procedure ends here and the Jammer will show the icon:



which means the input values are only temporary saved and will be lost at next power off/on of the Jammer.

This feature helps you to play with values until you find a good (new) setting. Take note of the new settings, then enter the Programming procedure to input (and permanently save) the new tested values.

CAUTION.

If the actuator tray is accidentally operated, filling will be dispensed out of the nozzles

10.0 MAINTENANCE

By keeping the machine cleaned after every period of use, it should operate smoothly, hygienically and economically.

If not kept clean, it may gum up and fail to operate.

No other maintenance should be required.



11.0 PROBLEM SOLVING

NO JAM DELIVERED

- 1.0 Check lead is plugged into the machine and the power socket.
- 2.0 Check that there is filling in the hopper
- 3.0 Check that the filling is not solid.
NOTE – Always break down jam from its jell state before placing in hopper and only use seedless jams and fillings.

If machine still has a problem please contact Mono Service Dept.

JAM LEAKS FROM HOPPER BASE

- 1.0 Check that the pump plate seal (1) has not been left out after cleaning.

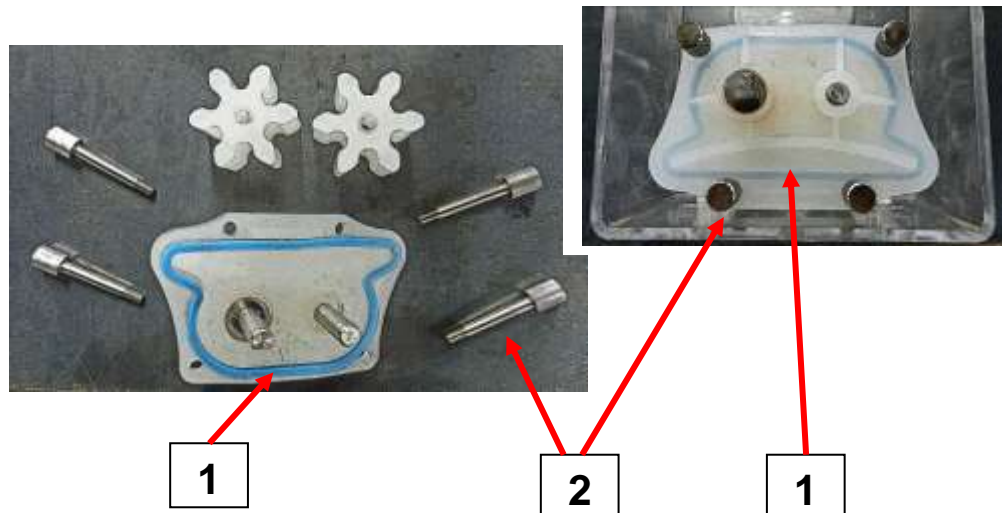

- 2.0 Check that pump assembly is not damaged.
- 3.0 Check that the thumbscrews (2) are tight but not over-tight (finger-tight only)

If machine still has a problem please contact Mono Service Dept. (see last page).

SERVICE PORT OPERATION

The rear panel USB port is used to plug a common USB Pen-Drive.(USB stick)

You can either:

- Load data from the Pen-Drive
- Save data to the Pen-Drive.

Features of the Pen-Drive

Format of the Pen-Drive

You need any commercially available USB 2.0 (or even 3.0) Pen-Drive, formatted with FAT32.

Files on the Pen-Drive

You do not need to have a “dedicated” Pen-Drive for the Jammer.

You can use your personal one, but you must have a folder named **JAMMER**.

This folder is the place where you can either store your data from Jammer or where you can load data to the Jammer.

The **JAMMER** main folder must include another two sub-folders, named **TO** and **FROM**.

- **TO**
is the sub-folder (inside the main JAMMER folder) where data from the Jammer is saved to the Pen-Drive.
- Files include:
 - Recipes
 - Bitmaps of the Icons
 - Actual Bootloader of the Jammer’s mainboard
 - Actual Firmware of the Jammer’s mainboard
- **FROM**
is the sub-folder (inside the main JAMMER folder) where data from the Pen-Drive is loaded into the Jammer.
- Files include:
 - Recipes
 - Bitmaps of the Icons
 - Actual Bootloader of the Jammer’s mainboard
 - Actual Firmware of the Jammer’s mainboard

Update Jammer Software & Data from the Pen-Drive

The procedure is very simple.

1. Power Jammer OFF
2. Plug the Pen-Drive into the USB port at the rear I/O Panel
3. Press  (“Down”) key on the keyboard
4. Keep the key pressed and power Jammer ON
5. Keep the key pressed and look at the keyboard LED: it should blink (slowly) to signal that the Jammer has “understood” an update session
6. Keep the key pressed until the keyboard LED blinks quickly
7. You can release the key now
8. The LED turns fixed ON while the update is in progress
9. At the end of the procedure:
 - If all has gone OK then the display will show the updated bootloader version and the updated firmware version
 - If anything has gone wrong then the keyboard LED blinks continuously and the Jammer is blocked. **If this should happen, however, you can restore the Jammer to Factory Defaults.**

Save Jammer Software & Data to the Pen Drive -

The procedure is very simple.

1. Power Jammer OFF
2. Plug the Pen-Drive into the USB port at the rear I/O Panel
3. Press  (“Up”) key on the keyboard
4. Keep the key pressed and power Jammer ON
5. Keep the key pressed and look at the keyboard LED: it should blink (slowly) to signal that the Jammer has “understood” a save-data session
6. Keep the key pressed until the keyboard LED blinks quickly
7. You can release the key now
8. The LED turns fixed ON while the saving procedure is in progress
9. At the end of the procedure the Jammer restarts as if it had just turned on.

Notice: during the save action to the Pen-Drive the Jammer checks for a correct file save to the Pen-Drive, so if the Jammer restarts, you can be sure the data on the Pen-Drive is ok.

Restore the Factory Defaults

In case the Jammer gets... “jammed” after an update procedure badly terminated, you can restore the Jammer loading the Factory Defaults.

This will restore the Jammer but you will lose your own recipes.

The restore procedure **does not need any USB Pen-Drive**.

1. Power Jammer OFF
2. Press the  “Settings” key
3. Keep this key pressed and power the Jammer ON
The keyboard LED will stay fixed ON
4. Keep the key pressed for at least another 5 seconds after power on.
5. You can release the key
6. The Jammer loads Factory Defaults from its on board Flash memory
7. When finished:
 - a. If all is OK, then the Jammer restarts as if it had just turned on;
 - b. If anything is still wrong, the LED will blink and the Jammer will stay blocked.
In this case the Jammer needs service.
Send it back to the factory for repair.

Check the Software Version

In case you need to know the actual version of the Bootloader and of the Firmware, which are running inside the internal control board’s processor, follow this procedure:

1. Turn Jammer OFF
2. Press the  “Program” key
3. Keep this key pressed and power the Jammer ON
4. Keep the key pressed for at least another 5 seconds after power on.
5. You can release the key
6. You will see the Display showing the Bootloader current version and the Firmware current version.
7. Turn the Jammer OFF
8. To use the Jammer now, power it ON without any key pressed.

Dust Proof Covers for the Rear I/O Panel

We provide dustproof rubber covers for both the USB port and for the foot pedal socket. These are easily removed by pulling them out of their respective sockets. After usage plug them back into the sockets. Do not lose them!

12.0 SPARES AND SERVICE

If a fault arises, please do not hesitate to contact the Customer Service Department, quoting the **machine serial number** on the silver information plate of the machine and on the front cover of this manual.

**Queensway
Swansea West Industrial Estate
Swansea.
SA5 4EB
UK**

email:spares@monoequip.com

Spares Tel. +44(0)1792 564039

Web site:www.monoequip.com

**Tel. +44(0)1792 561234
Fax. 01792 561016**



13.0 ELECTRICAL INFORMATION

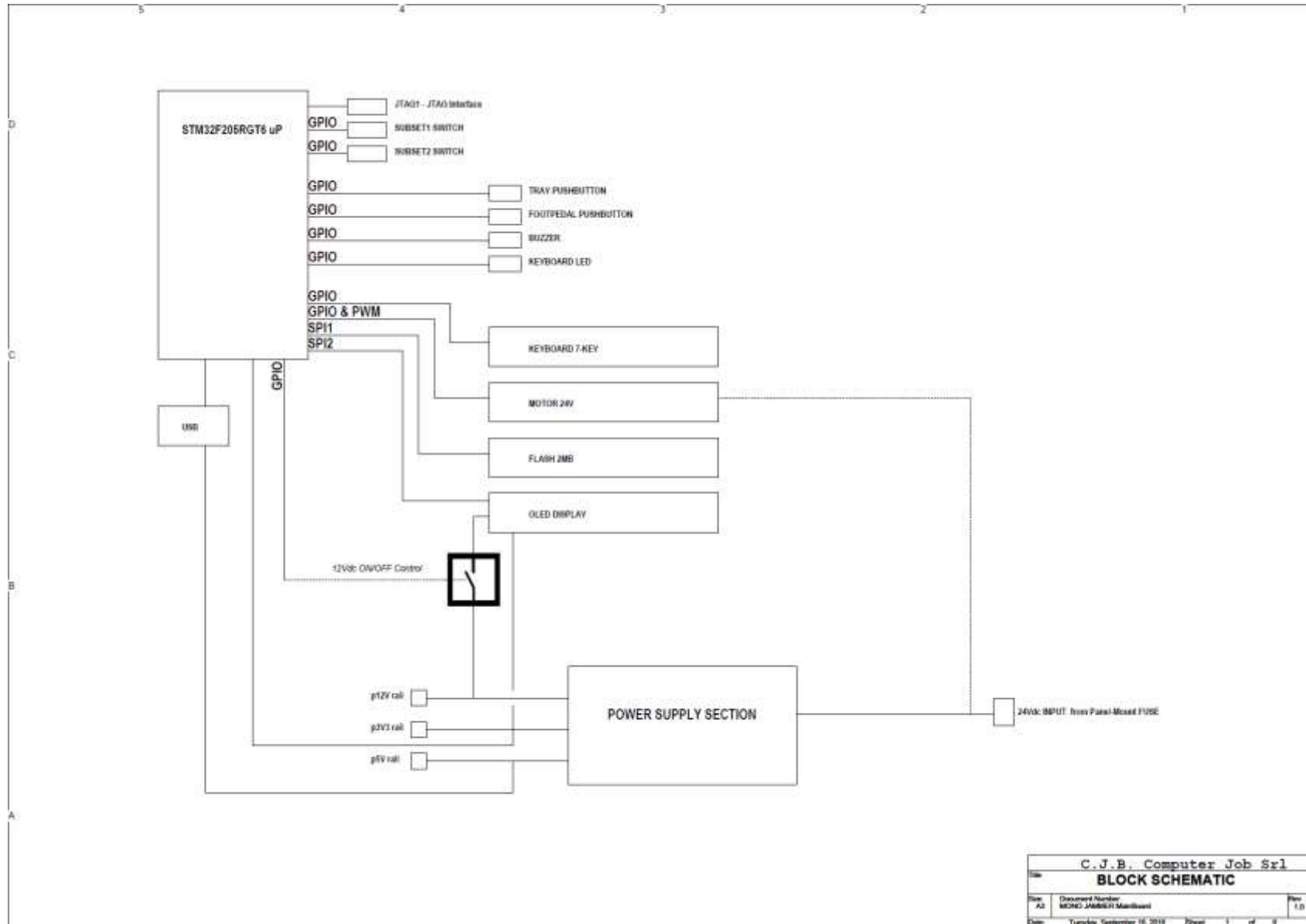

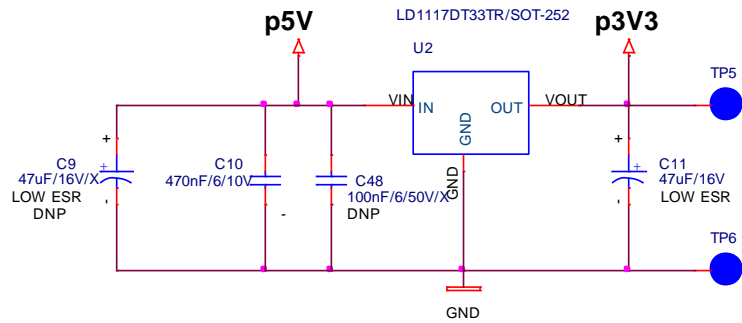
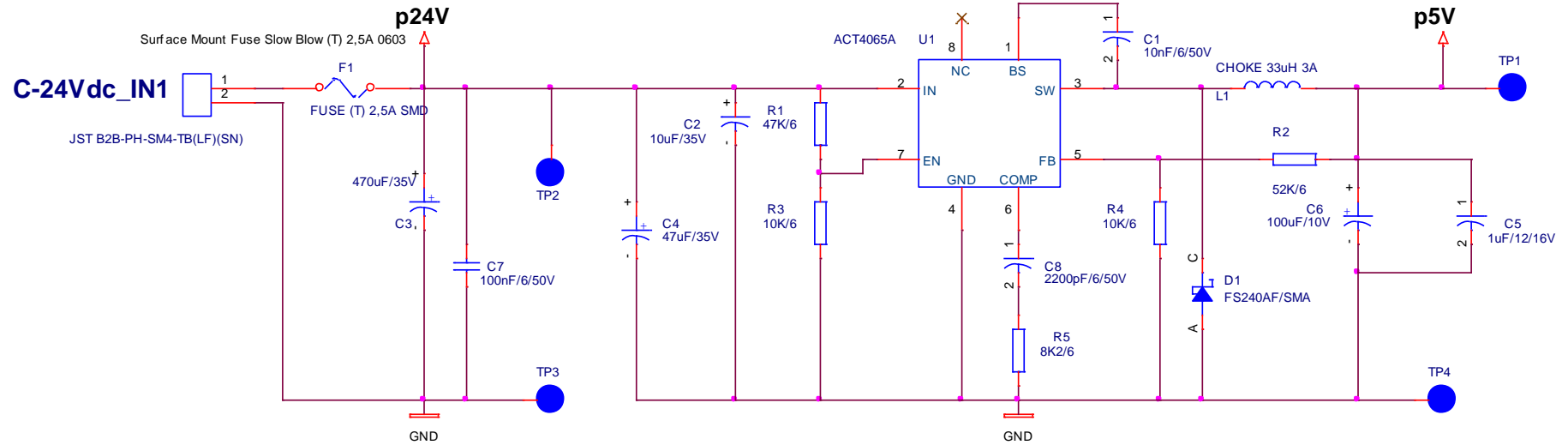

DESIGN WIDE COPPER AREA UNDER LD1117 TO HELP COOLING

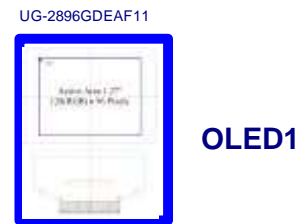

C.J.B. Computer Job Srl		
Title Power Supply		
Size A4	Document Number MONO JAMMER MainBoard	Rev 1.1
Date: Friday, November 23, 2018	Sheet 2	of 8

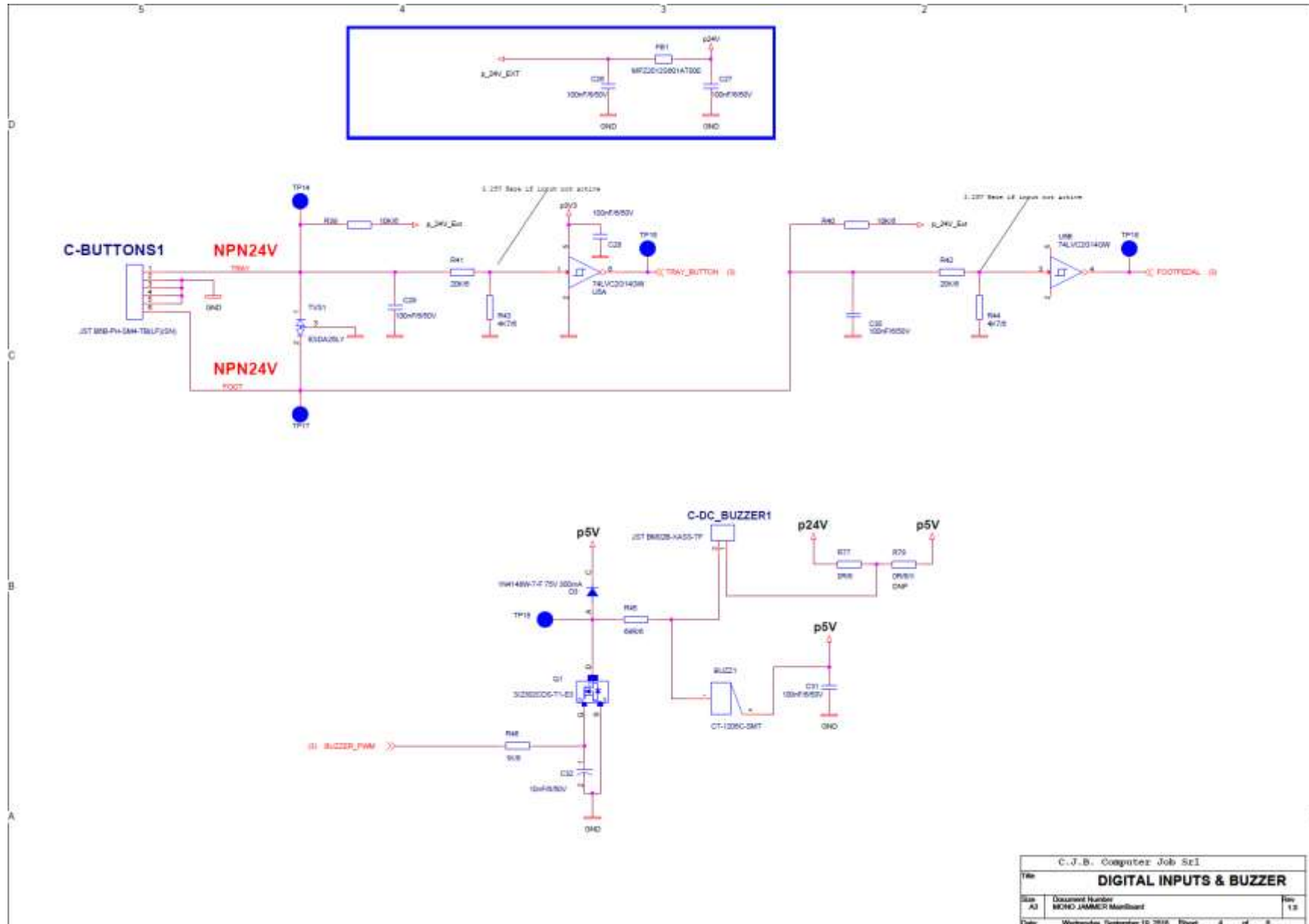

C.J.B. Computer Job Set		
Title: DIGITAL INPUTS & BUZZER		
Size: A3	Document Number: B0300-ANAMEO Mainboard	Rev: 1.2
Date: Wednesday, September 16, 2016	Sheet: 4	of 8

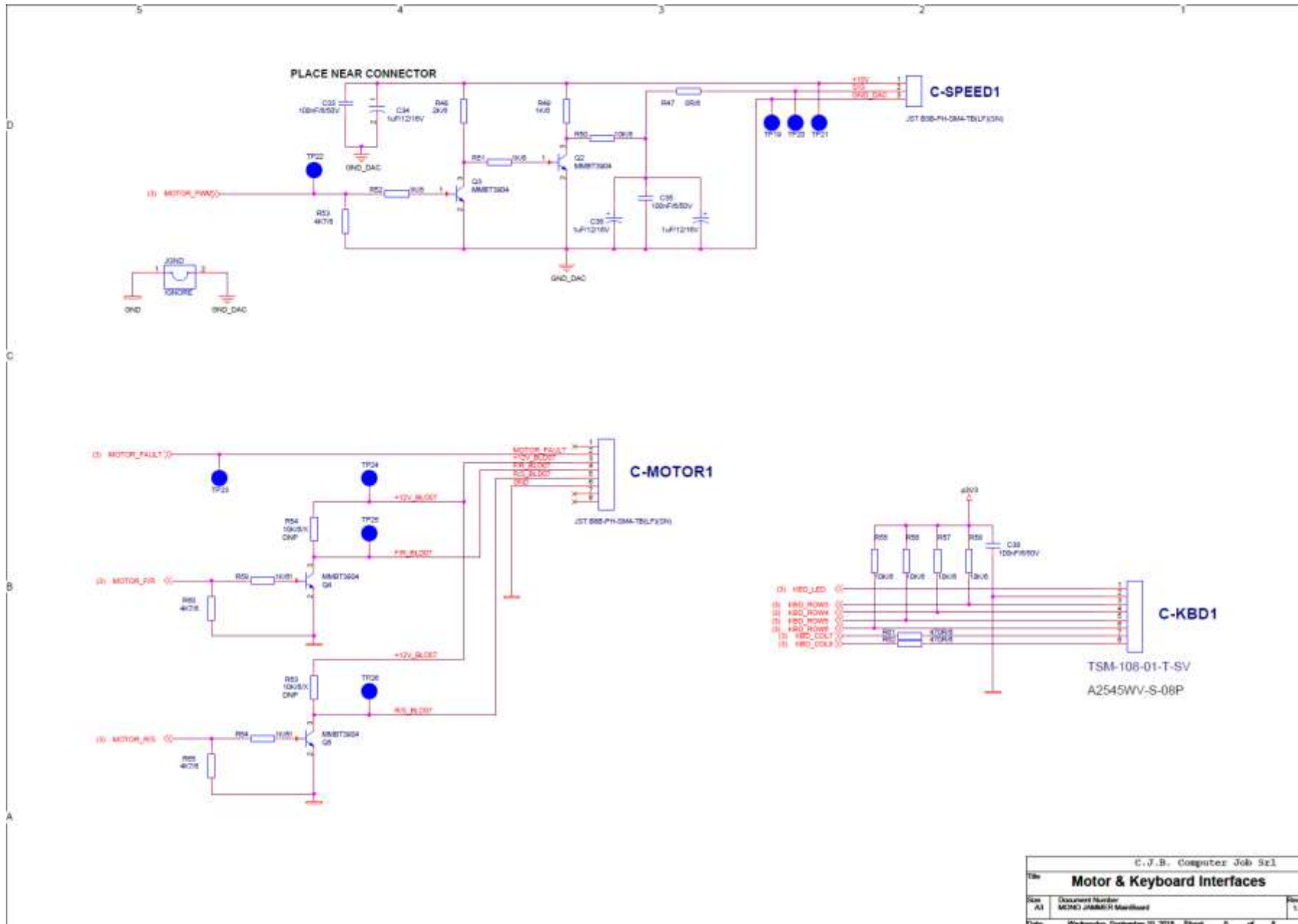

C.F.B. Computer Job Srl			
Title	Motor & Keyboard Interfaces		
Doc No	Document Number	Rev	1.0
A1	MC902 JAMMER Keyboard		
Date:	Wednesday, September 10, 2016	Sheet	0 of 8

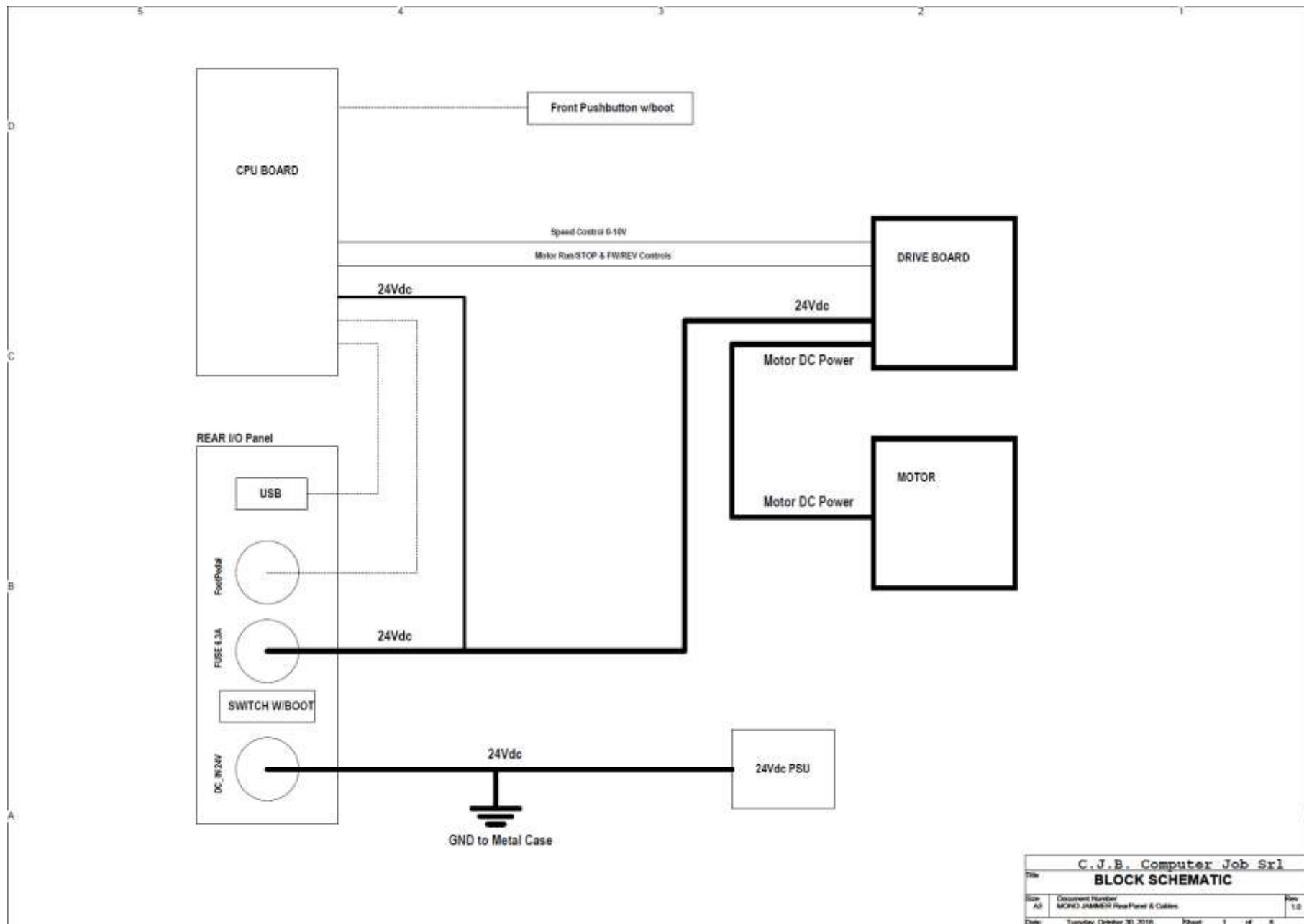

C.J.B. Computer Job Srl		
Title: BLOCK SCHEMATIC		
Size: A3	Document Number: MICRO JAMMER Front Panel & Cables	Rev: 1.0
Date: Tuesday, October 30, 2016	Sheet: 1	of 8



MONO

Queensway
Swansea West Industrial Estate
Swansea.
SA5 4EB
UK

email:spares@monoequip.com

Spares Tel. +44(0)1792 564039

Web site:www.monoequip.com

Tel. +44(0)1792 561234

Fax. 01792 561016